

STICK T5 DIRECT/INDIRECT LOUVER

40 SERIES

Direct/Indirect Trim
with Specular Louvers

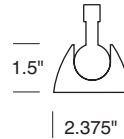
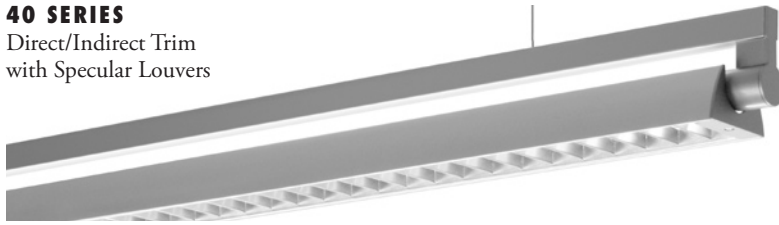

TYPE:

ORDER NUMBER:

PROJECT:

Model #

Voltage

Options*

Dimming*

1-120V

DPB S100P

SD3 SD9

2-277V

SEM13 SAC

SD5 SD10

SMB SFBS

SD8

SWRB SFBW

*See back page for details.

Please review mounting info before ordering.

Run Length:

(enter in multiples of 4 ft.)

Standard	Length	Wattage
ST48228.440	8'	2-28
ST48254.440	8'	2-54

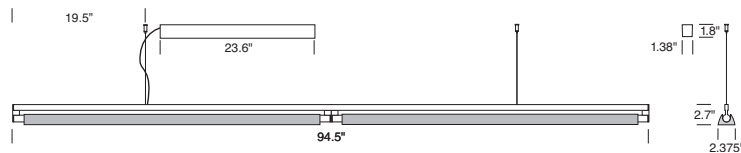

Rail Mount	Length	Wattage
ST68228.440	8'	2-28
ST68254.440	8'	2-54

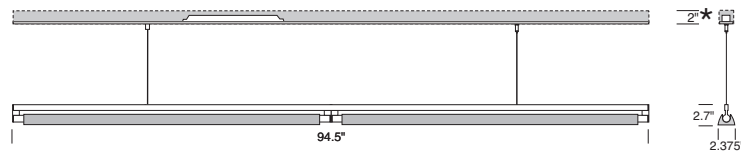

*Rail parts ordered separately.

Standard	Length	Wattage
ST44128.440	4'	1-28
ST44154.440	4'	1-54

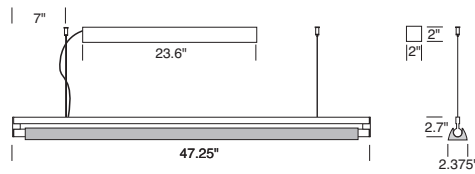

Rail Mount	Length	Wattage
ST64128.440	4'	1-28
ST64154.440	4'	1-54

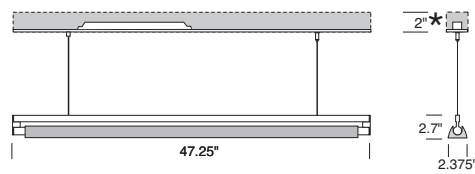

*Rail parts ordered separately.

STICK CONNECTING SECTIONS

STR open on right side of cord

STM open on both ends

STL open on left side of cord

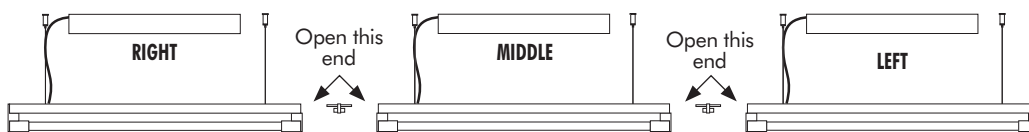

Standard	Length	Wattage
STR48228.440	8'	2-28
STR48254.440	8'	2-54
STR44128.440	4'	1-28
STR44154.440	4'	1-54

Standard	Length	Wattage
STM48228.440	8'	2-28
STM48254.440	8'	2-54
STM44128.440	4'	1-28
STM44154.440	4'	1-54

Standard	Length	Wattage
STL48228.440	8'	2-28
STL48254.440	8'	2-54
STL44128.440	4'	1-28
STL44154.440	4'	1-54

Rail Mount	Length	Wattage
STR68228.440	8'	2-28
STR68254.440	8'	2-54
STR64128.440	4'	1-28
STR64154.440	4'	1-54

Rail Mount	Length	Wattage
STM68228.440	8'	2-28
STM68254.440	8'	2-54
STM64128.440	4'	1-28
STM64154.440	4'	1-54

Rail Mount	Length	Wattage
STL68228.440	8'	2-28
STL68254.440	8'	2-54
STL64128.440	4'	1-28
STL64154.440	4'	1-54

DELRAY
LIGHTING
INCORPORATED

ST4 & ST6 / 40

BURBANK,
CALIFORNIA,
91505
WWW.
DELRAY
LIGHTING.
COM

4' 54W

ST44154.440

1-54W HO T5
G5 socket
Total lumens: 5000 mean
Total luminaire efficiency: 55.6%

CP DISTRIBUTION

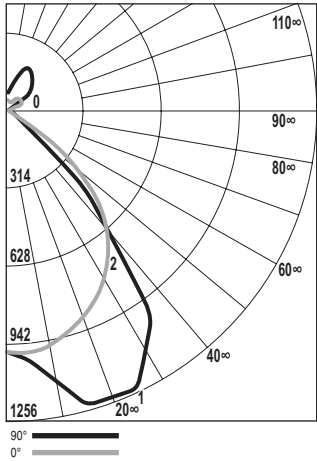

COEFFICIENTS

% CEILING 80	(20% FLOOR)		
	% WALL 70	50	30
0	64	64	64
1	59	57	55
2	55	51	47
3	50	45	41
4	46	40	36
5	42	36	31
6	39	32	28
7	36	29	24
8	33	26	22
9	31	24	20
10	29	22	18

OPTIONAL J-BOX COVER

Cover plate mounts to maximum 4" square J-box. Ballast housing mounts to wall on top of cover plate, which may be painted to match ceiling or wall, and includes two mounting spacers to offset cover thickness. Order **ST100P**.

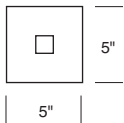

FLUSH MOUNT

22" flush mount ballast housing, for joist mount rough-in. Order **SFBS** (silver) or **SFBW** (white).

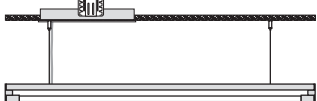

STICK CONSTRUCTION

INLINE PENDANT

- ST4 is a 4' or 8' dual inline pendant fixture that can stand alone or be connected to other 8' or 4' Stick sections. (See connection order info on opposite side). Each section requires its own power feed.
- ST6 may be connected to

- a continuous overhead rail system.
- Zinc aluminum alloy and aluminum extrusion, with a matte anodized finish.
- Suspended with field-adjustable aircraft cable, with push-button glider.
- G5 twist-in lamp holders.

- 8' gray 18 AWG power cord.
- Standard output electronic ballasts are 120/277V, 50/60 Hz universal, in a remote housing.
- Back plate has a 7/8" opening for direct conduit feed and is not intended for J-box mount.
- U.L. listed for damp locations.

DIMMING INFORMATION

Standard Dimming

Due to lamp lead length limitations for dimming ballasts, all fixtures with two lamps require 4' ballast housings with a maximum cord drop of 3' on both sides of fixture to accommodate two ballasts. Voltage must be specified.

DPB Option

Mounts ballast housing directly to the fixture, for longer than 3 ft. mounting heights. Accommodates all dimming ballasts for 4 ft. and 8 ft. fixtures.

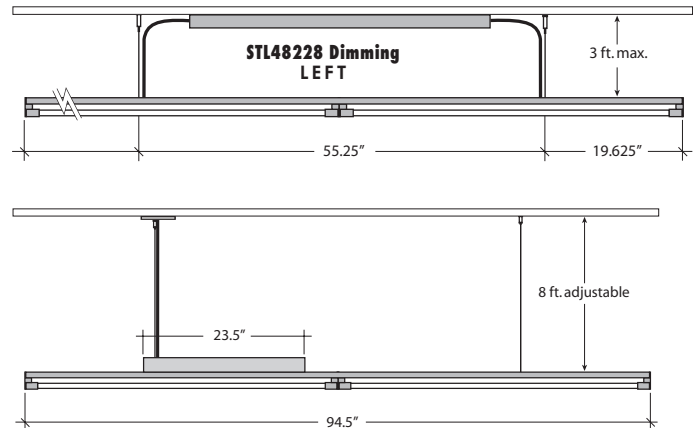

DIMMING BALLASTS

Cat. #	Type	Wattage
SD3	Advance Mark X	54
SD5	Advance Mark VII	54
SD8	Lutron Hi Lume FDB	28/54
SD9	Lutron Eco System	28/54
SD10	Stepped dim, 50% for 2x28 only	2x28

BALLAST/RAIL MOUNT INFO

Stick ballast and rail housings are shipped with one opening for direct connection to conduit with a third party 1/2" fitting (as shown below). To locate input power elsewhere, an alternate 7/8" opening may be drilled at the job site anywhere along the top of the aluminum rail housing.

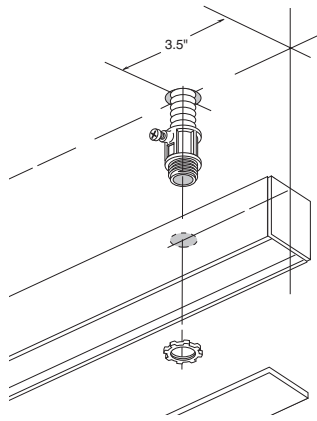

EMERGENCY BALLASTS

Emergency ballast provides 1300 lumens for 90 minutes. Charge light and test switch are visible from below. On 2 lamp fixture, lamp closest to power cord gets emergency power. Maximum 4' pendant length recommended. Voltage must be specified. Order **SEM13**.

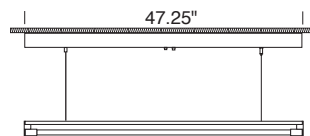

RECESSED BALLAST

For suspended ceilings only. Order **SWRB**.

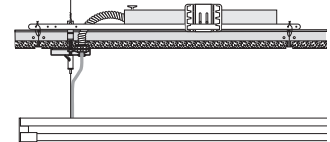

CONTINUOUS MOUNT INFORMATION

Stick features a sliding support cable at the end opposite the power cord, for those times when a straight shot to the ceiling isn't possible.

STJA—swivel connector rotates 240° and adds 7/16" to the overall length.

